

Catalog No. 8339

INSTALLATION INSTRUCTIONS

READ THOROUGHLY BEFORE BEGINNING

2 5/16" FOLDING BALL GOOSENECK HITCH COVERED BY U.S. PATENT NOS. 5,738,363 & 5,893,575

Note: GM composite (NON METAL) bed will require Installation Kit #58209

IMPORTANT!

This product is intended to be used with *Towing Products* manufactured Rail Kits. If the Gooseneck Hitch installation is made with *Towing Products* manufactured Rail Kits, the installation instructions for the Gooseneck Hitch are included as part of the *Towing Products* Rail Kit installation instructions. Give this installation instruction to vehicle owner after installation is complete.

General instructions for fabricated support structures.

IF *TOWING PRODUCTS* MANUFACTURED RAIL KITS ARE NOT USED, THIS PRODUCT BECOMES A GENERAL APPLICATION PRODUCT. IT IS THE RESPONSIBILITY OF THE INSTALLER TO SELECT STRUCTURALLY SAFE MATERIALS AND LOCATIONS FOR ATTACHMENT. INSTALLATION INFORMATION FOLLOWS.

- MAXIMUM RATINGS -

DO NOT EXCEED LOWER OF TOWING VEHICLE MANUFACTURER'S RATINGS OR THOSE LISTED BELOW:

25,000 LB GROSS TRAILER WEIGHT

6,250 LB VERTICAL LOAD

TOOLS REQUIRED:

Hand drill
Drill bits - 1/4", 5/8", 3/4"
Sockets and Wrenches - 9/16" & 15/16"
Center Punch
Torque Wrench
Saber Saw
Files - round and flat
Hammer

Fig. 1

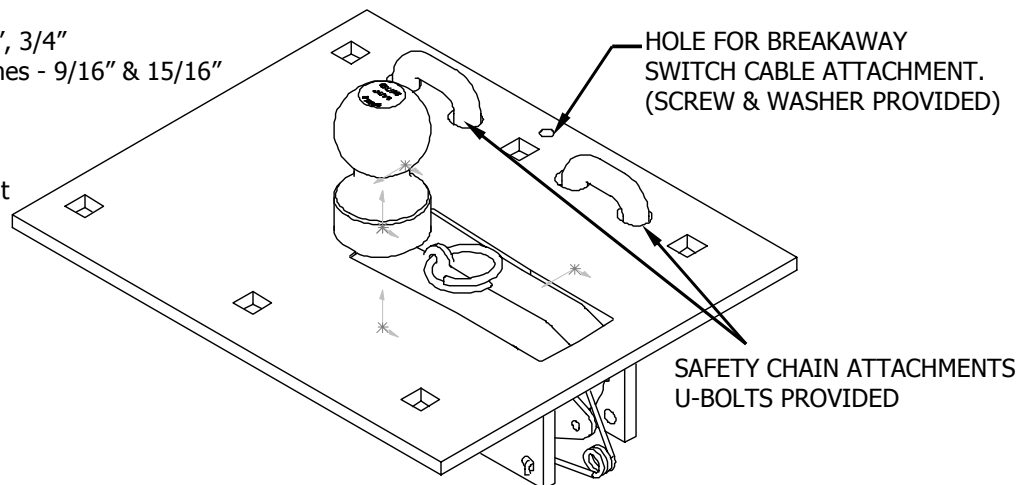

NOTE: CHECK HITCH FREQUENTLY, MAKING SURE ALL FASTENERS ARE PROPERLY TIGHTENED. A HITCH OR BALL WHICH HAS BEEN DAMAGED SHOULD BE REMOVED AND REPLACED. OBSERVE SAFETY PRECAUTIONS WHEN WORKING BENEATH A VEHICLE AND WEAR EYE PROTECTION. FOLLOW VEHICLE MANUFACTURER'S SPECIFICATIONS FOR MAXIMUM TRAILER WEIGHT. DO NOT CUT ACCESS OR ATTACHMENT HOLES WITH A TORCH.

PARTS LIST:

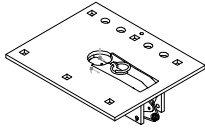

BALL ASSEMBLY

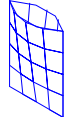

PART BAG



INSTRUCTION SHEET

PART BAG CONTENTS

DESCRIPTION	QTY.
5/8-11 X 2.5 GRADE 5 CARRIAGE BOLTS	6
5/8-11 NUT	6
5/8 LOCKWASHER	6
5/8 U-BOLT ZINC PLATED	2
5" SPRING	4
5/8-18 LOCKNUT	4
9/16 FLAT WASHER	8
3/8 FLAT WASHER	1
24-9 X 1" TAP SCREW	1

Note: GM composite (NON METAL) bed will require Installation Kit #58209

INSTALLATION INSTRUCTIONS:

- The following guidelines must be followed before installation begins:
 - The hitch ball must be located along the truck's fore/aft centerline.
 - The hitch ball centerline must be located above and forward of the rear axle of the truck.
 - Adequate clearance must be provided between the gooseneck trailer and the rear of the vehicle so that the gooseneck trailer does not contact any part of the truck during turning.
 - Adequate clearance must be provided between the forward corners of the gooseneck trailer and the cab of the truck.
 - Determine that the ball position and under vehicle supports do not interfere with any vehicle crossmembers, brake lines, electrical wiring, cables, fuel lines or vents.
- With hitch ball center marked on the truck, lay template in the bed of the truck. Make sure that the template is oriented properly per notes on the template. If truck is equipped with a bed liner a 14.5" x 12" section of the bed liner must be cut out so that the gooseneck platform can contact the metal truck bed corrugations.
- Center punch the holes that will be used to cut out the truck bed.
- Drill 1/4" pilot holes (size will depend on the width of blade in saber saw).
- Cut out truck bed. File the edges as needed.
- Install platform into opening.
- Use the installed platform as a guide to drill 5/8" diameter holes through the truck bed and/or under vehicle supports for the carriage bolts and drill 3/4" diameter holes for U-bolts.

Before drilling, make sure the platform is oriented square to the truck centerline and does not interfere with any vehicle crossmembers, brake lines, electrical wiring, cables, fuel lines or vents.

- Before installing 5/8" carriage bolts through the platform, shims (not provided) must be placed between the platform and the bed and between the under vehicle structure and the bottom of the bed. These shims are necessary to prevent the truck bed corrugations from collapsing when the carriage bolts are tightened. See Fig. 2.
- Install 5/8" x 2.50" Grade 5 carriage bolts through the platform, shims and under vehicle supports. Secure with lock washers and nuts. Torque nuts to 150 LB-FT.
- Install the (2) U-bolts through the platform. From under the truck install large flat washer over the U-bolt followed by a spring, another large flat washer and secure with a thin 5/8" jam nut. Repeat for the other legs of the U-bolts. The 5/8" jam nuts are to be tightened until 3 threads are visible past the bottom of the nut.

Fig. 2

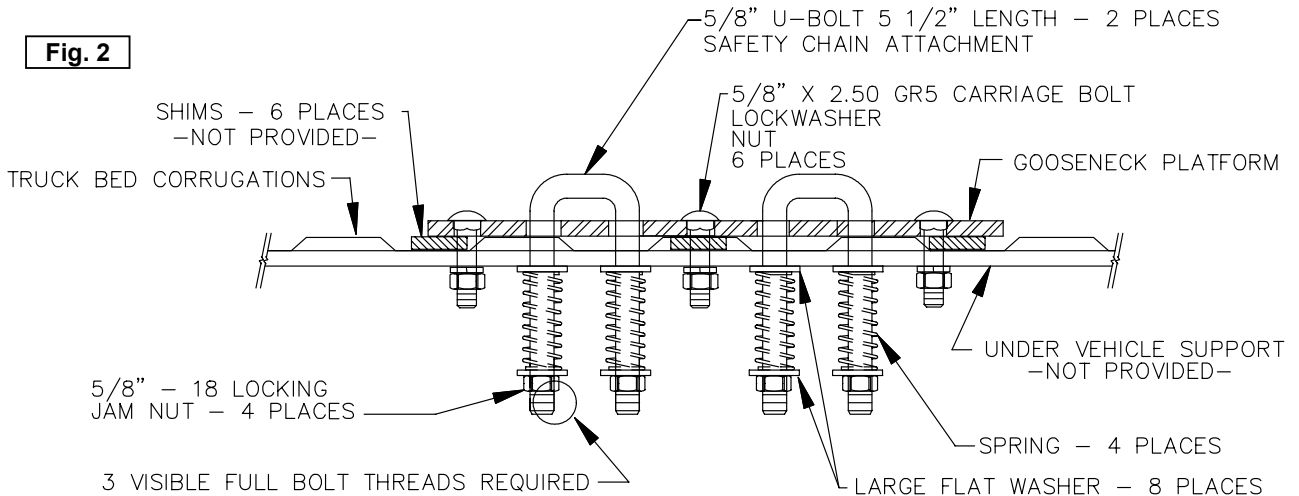

OPTIONAL LAYOUT METHOD USING DIMENSIONS

CAUTION BEFORE DRILLING, CUTTING, OR SAWING CHECK BELOW BED TO ENSURE FUEL LINES, BRAKE LINES, WIRES, ETC. WILL NOT BE DAMAGED.

Fig. 3

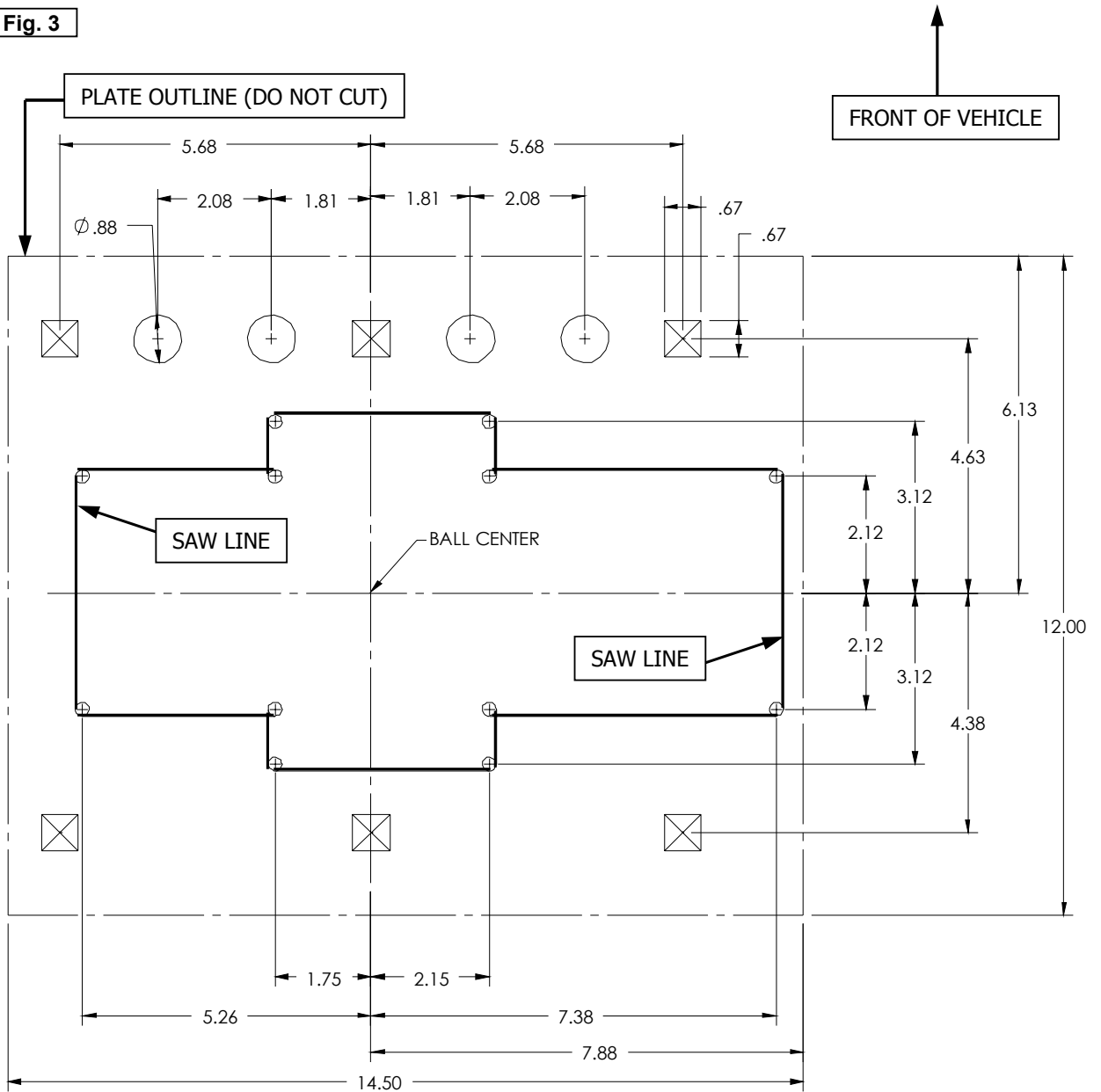

CAUTION BEFORE DRILLING, CUTTING, OR SAWING CHECK BELOW BED TO ENSURE FUEL LINES, BRAKE LINES, WIRES, ETC. WILL NOT BE DAMAGED.

FOLDING BALL GOOSENECK OPERATION

The ball assembly offers several features with the user in mind.

- Easily accessible lift ring (Fig. B.)
- Two spring loaded safety chain mounts. (Fig. E.)
- Easily accessible grease zerk (Fig. A.)
- Ball detent lock backup to provide double coverage in preventing ball cover from opening unintentionally.
- Spring loaded folding mechanisms to assist actuation and prevent rattle.
- Chrome plated decorative ball.

TO RAISE BALL IN UPRIGHT POSITION

1. Grasp lift ring and raise cover until the spring holds the cover open. Grasp ball and rock it to its vertical position. See figures A-D.
2. Lower lift ring and cover such that it locks ball in upright position. See figure E.
3. Lift spring loaded safety chain U-bolts to attach safety chain.

To lower ball into horizontal position, repeat steps 1 then 2.

AFTER SYSTEM INSTALLATION AND BEFORE TOWING

Connect trailer to the tow vehicle following coupler manufacturer's operating instructions.

The coupler must be adjusted to provide about 6" of clearance between the bottom of the trailer nose and the top of the pickup bed sides.

Slowly back the trailer to a jackknifed position to the tow vehicle while checking to see there is adequate clearance between the gooseneck trailer and the rear of the vehicle. Also check to see there is adequate clearance between the forward corners of the gooseneck trailer and the cab of the truck. Slowly jackknife the truck and trailer in the opposite direction and check the clearances to the end of the truck and the cab.

FOLDING BALL GOOSENECK HITCH MAINTENANCE

- Keep ball envelope and pivoting mechanism free from dirt and debris.
- Lube ball cover pivot monthly with light weight oil or equivalent.
- Grease ball pivot at grease zerk monthly (See figure A)
- Lube ball detent regularly with light weight oil. Keep free from dirt and debris.
- Retorque all hardware monthly.

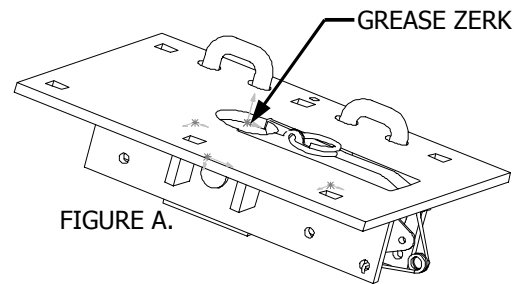

FIGURE A.

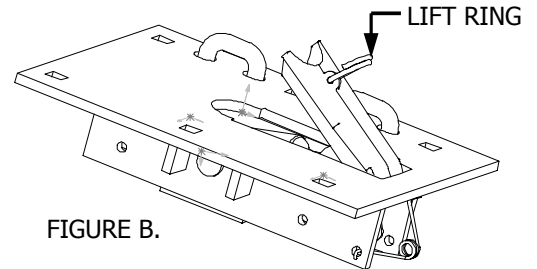

FIGURE B.

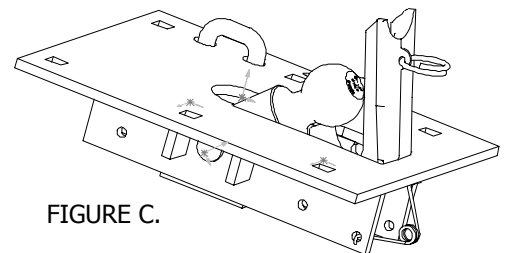

FIGURE C.

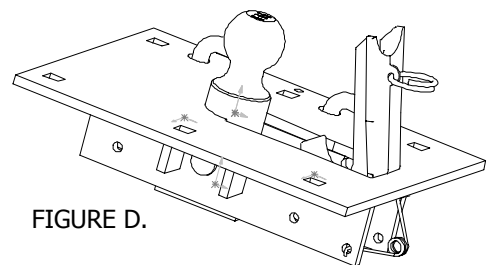

FIGURE D.

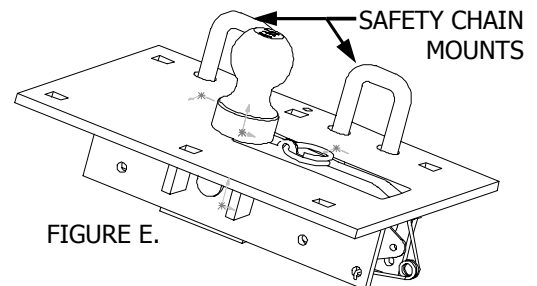

FIGURE E.

FOLDING BALL GOOSENECK HITCH SYSTEM

IMPORTANT INFORMATION ON TOWING

TOWING EQUIPMENT OWNERS: Make sure all operators of your equipment read and understand this information before towing. Save for reference. This will help you properly use and maintain your towing equipment. Refer to owner's manuals for your tow vehicle, trailer and other parts of your towing system. Learn the capabilities and limitations of each part. **GROSS TRAILER WEIGHT** and **VERTICAL LOAD** are the two most important items to consider. **THESE WEIGHTS MUST NEVER EXCEED THE LOWEST RATING OF ANY PART OF YOUR TOWING SYSTEM.** **GROSS TRAILER WEIGHT** is the weight of the trailer plus cargo. Measure **GROSS TRAILER WEIGHT** by putting the fully loaded trailer on a vehicle scale. **VERTICAL LOAD** is the downward force exerted on the ball by the trailer coupler. Use a vehicle scale to measure **VERTICAL LOAD** with the fully loaded trailer on a level surface and the coupler at normal towing height.

TRAILER COUPLERS

The coupler should be smooth, clean and lightly lubricated. Adjust per coupler manufacturer's instructions.

SAFETY CHAINS

Connect safety chains properly **EVERY TIME YOU TOW**. Attach securely through the U-bolts provided so they can not bounce loose. Leave only enough slack to permit full turning. Too much slack may prevent chains from maintaining control if other connections separate.

TRAILER LIGHTS, TURN SIGNALS, ELECTRIC AND BREAKAWAY SWITCH CONNECTIONS

Make these safety-critical connections **EVERY TIME YOU TOW**, no matter how short the trip. Check operation, including electric brake manual control, before getting on the road.

OTHER USEFUL EQUIPMENT

AIR SPRINGS, AIR SHOCKS, or HELPER SPRINGS are useful for some applications. A **TRANSMISSION COOLER** may be necessary for heavy towing. Many states require **TOWING MIRRORS** on both sides.

TIRE INFLATION

Check often. Follow tow vehicle and trailer manufacturer's recommendations.

CHECK YOUR EQUIPMENT/REPLACE WORN PARTS

Check ball, coupler, chains, and all other connections **EVERY TIME YOU TOW**. Re-check at fuel and rest stops.

NO PASSENGERS IN TRAILER!

Never allow people in the trailer while towing, under any circumstances.

TRAILER LOADING

Place heavy objects on the floor ahead of the axle. Balance the load side-to-side. Secure it to prevent shifting. **NEVER** load the trailer rear heavy. **LOAD THE TRAILER HEAVIER IN THE FRONT, BUT NOT GREATER THAN TONGUE WEIGHT RATING OF THE HITCH.**

DRIVING

The additional weight of a trailer affects acceleration, braking and handling. Allow extra time for passing, stopping, and changing lanes. A gooseneck trailer requires a large turning radius as the trailer tracks to the inside of turns. Severe bumps can damage your towing vehicle, hitch and trailer. Drive slowly on rough roads. **STOP AND MAKE A THOROUGH INSPECTION IF ANY PART OF YOUR TOWING SYSTEM STRIKES THE ROAD. CORRECT ANY PROBLEMS BEFORE RESUMING TRAVEL.**

WARNING

DO NOT MODIFY. Do not tow one trailer behind another, which may cause loss of control. Failure to heed warnings and follow instructions may result in serious personal injury or death, vehicle crash, and/or property damage.